

Proyecto: Apartamento A-101

Nivel: I

Habitaciones: 3

Net M²: 235.83

Area comunes: 23.53

Total M²: 259.36

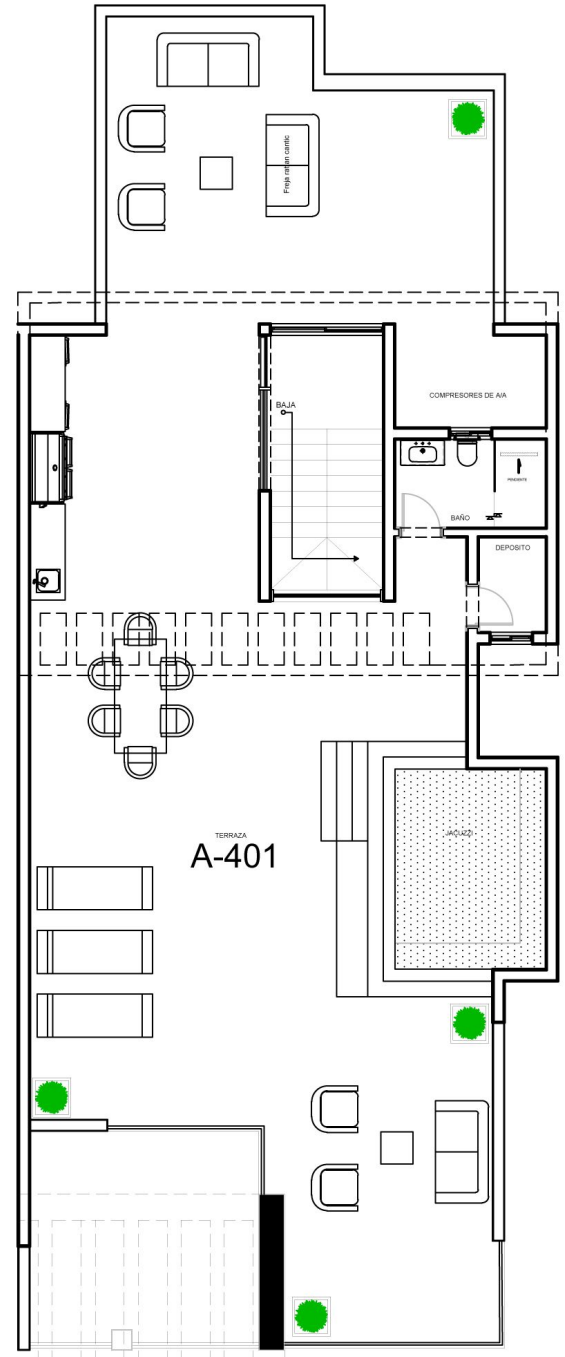
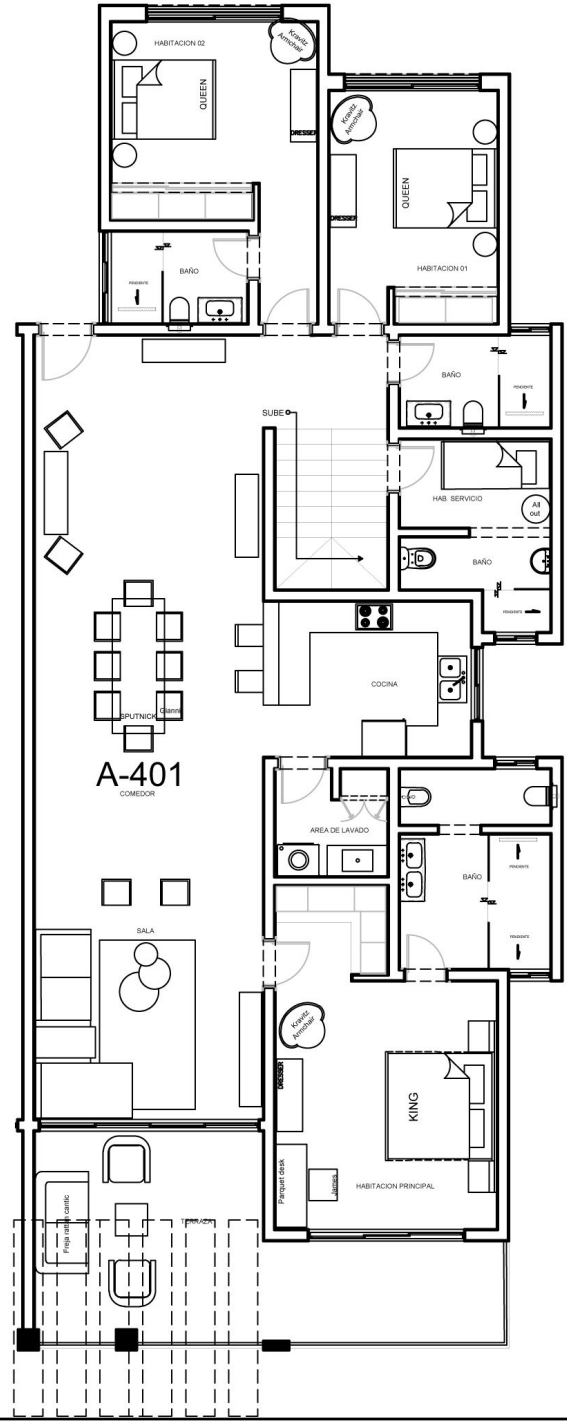
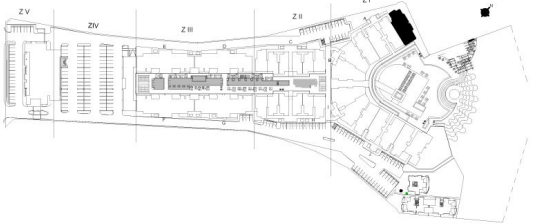

Proyecto: Apartamento A-401
Nivel: IV - V
Habitaciones: 3
Net M²: 235.83
Area comunes: 23.53
Terraza en azotea: 200.97
Total M²: 460.33

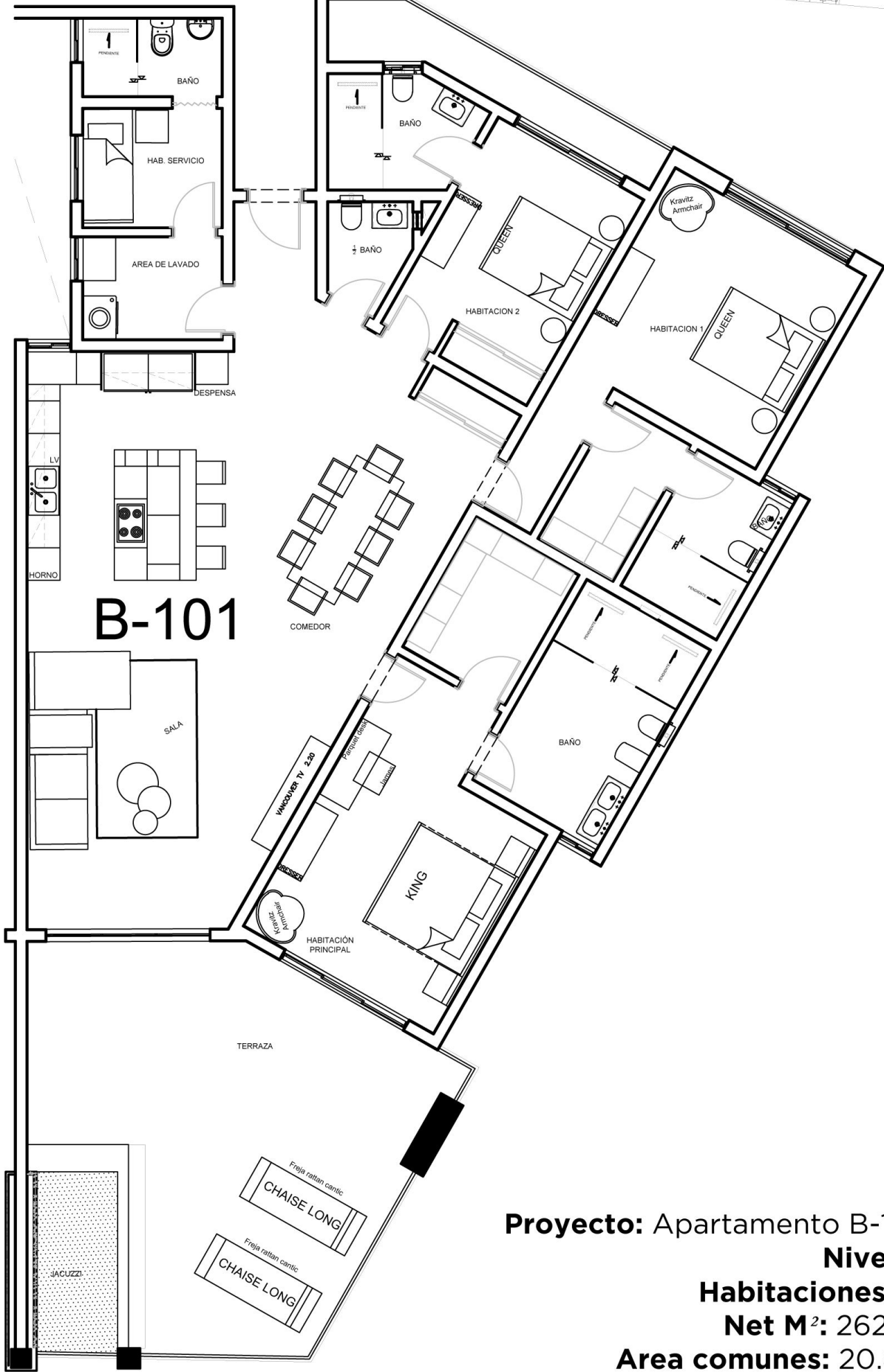
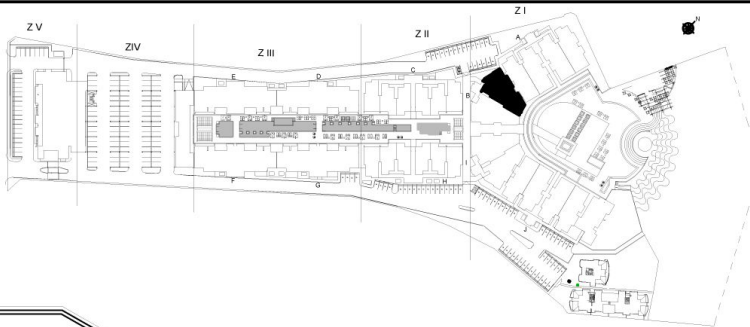

B-101

Proyecto: Apartamento B-101
Nivel: I
Habitaciones: 3
Net M²: 262.12
Area comunes: 20.80
Total M²: 282.92

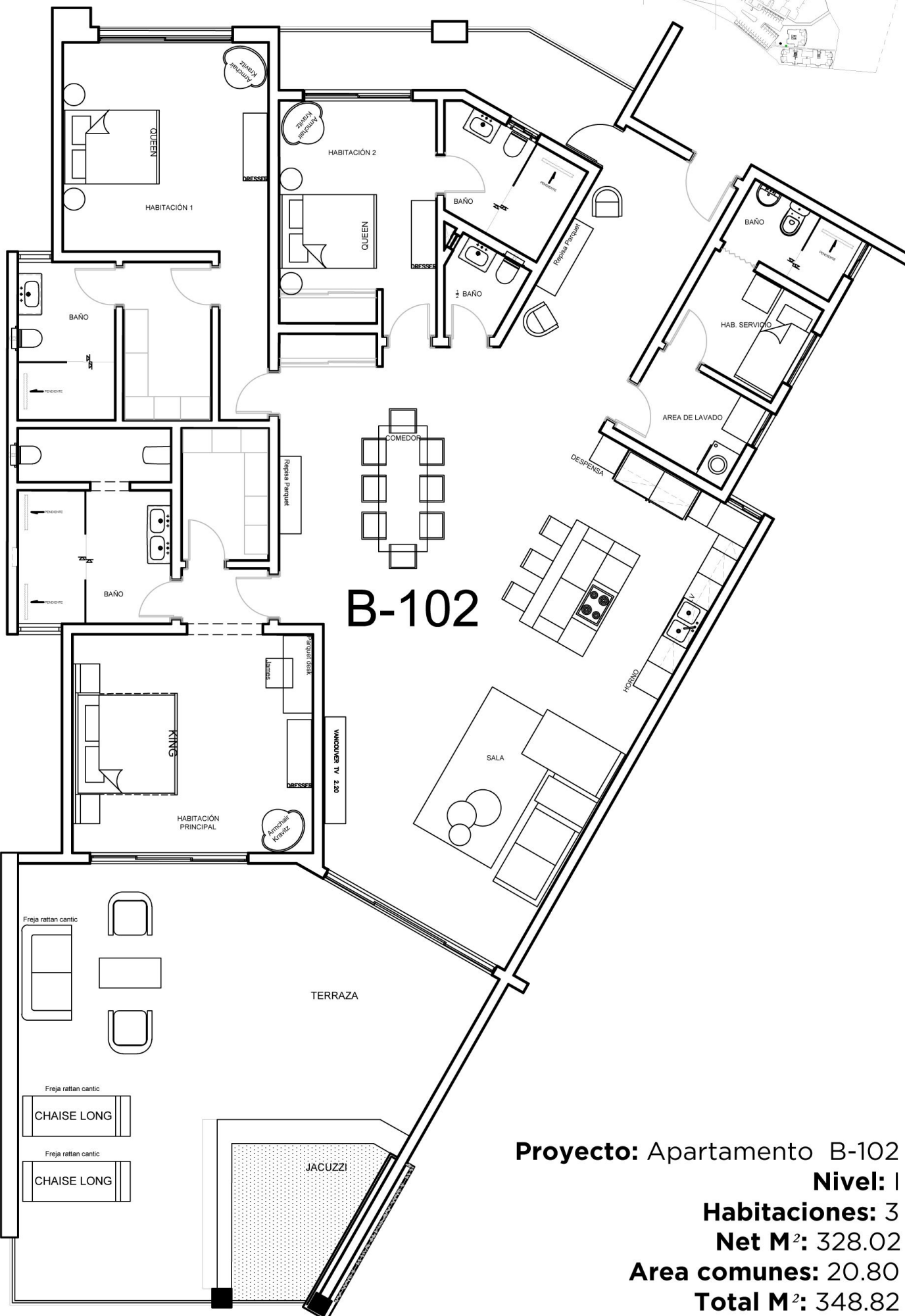
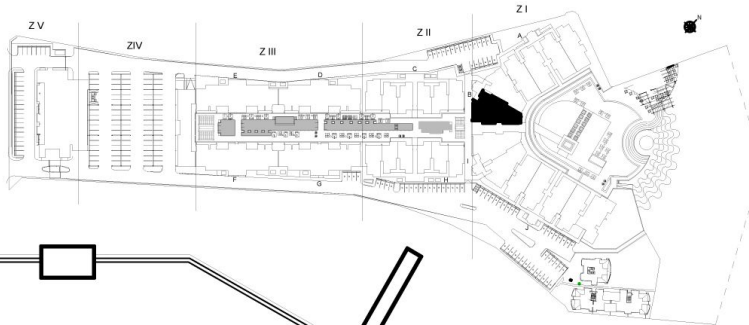

Proyecto: Apartamento B-102

Nivel: I

Habitaciones: 3

Net M²: 328.02

Area comunes: 20.80

Total M²: 348.82

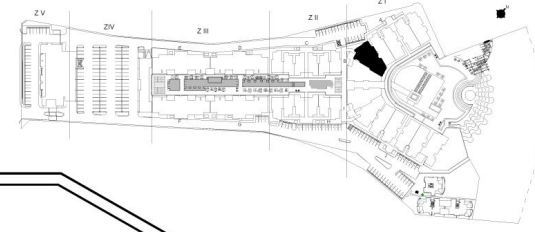

Proyecto: Apartamento B-401
Nivel: IV-V
Habitaciones: 3
Net M²: 262.12
Area comunes: 20.80
Terraza de Azotea: 251.77
Total M²: 534.69

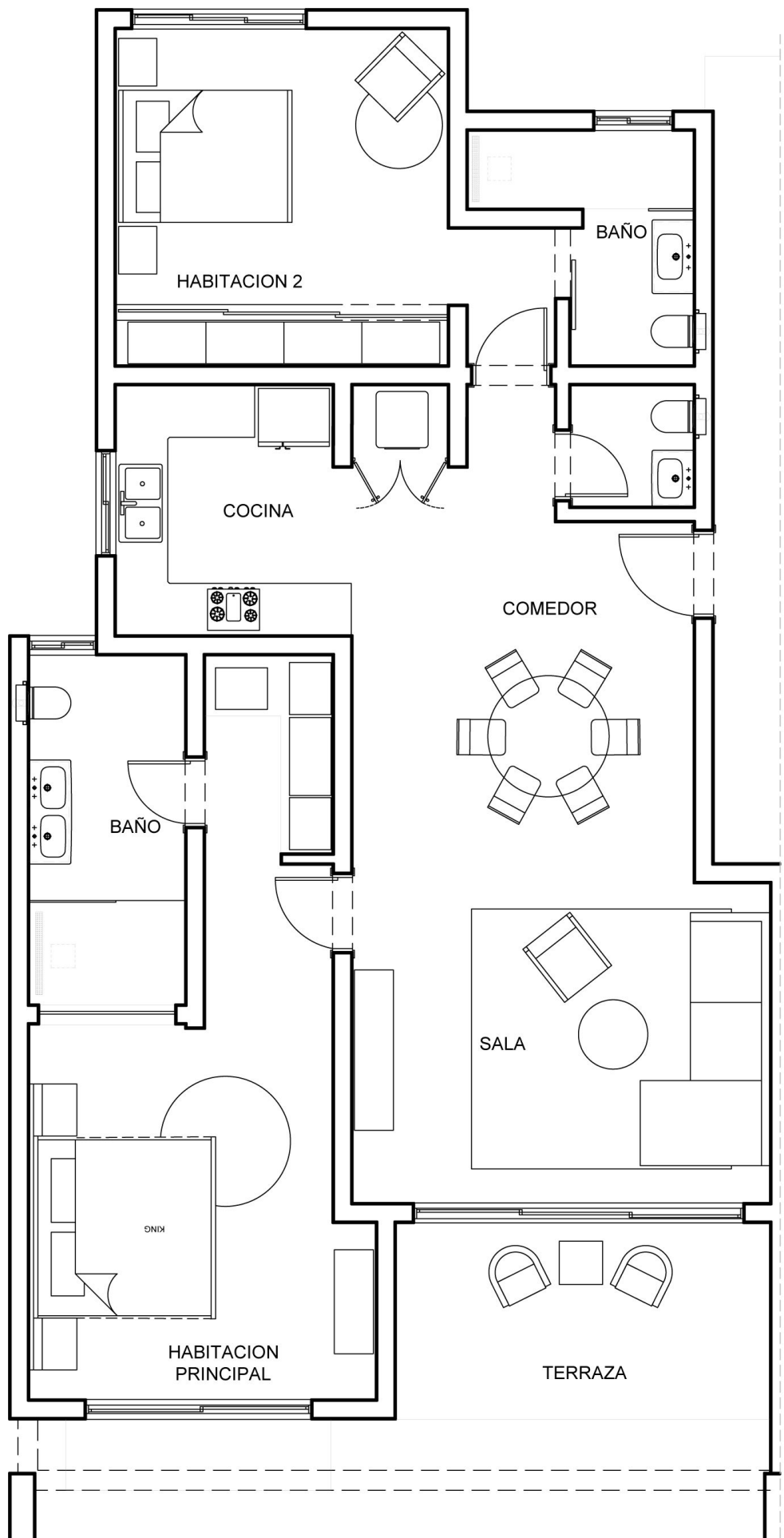

Proyecto:
Apartamento C-101
Nivel: I
Habitaciones: 2
Net M²: 128.34
Area comunes: 25.23
Total M²: 153.57

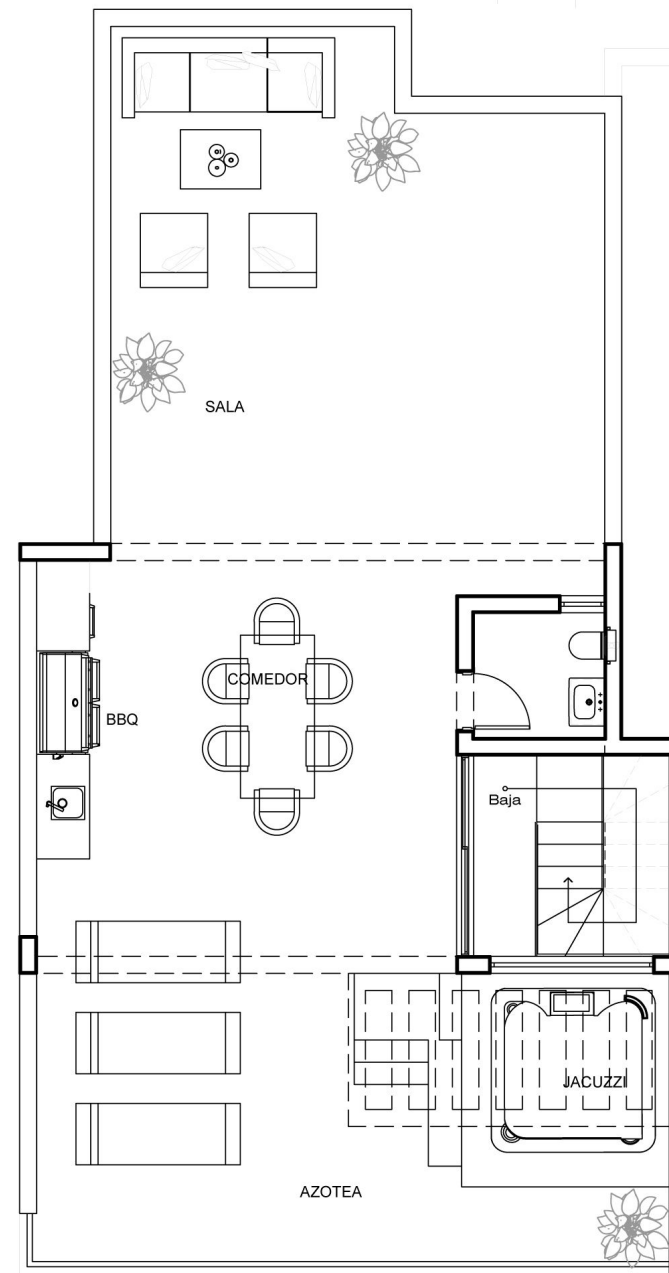
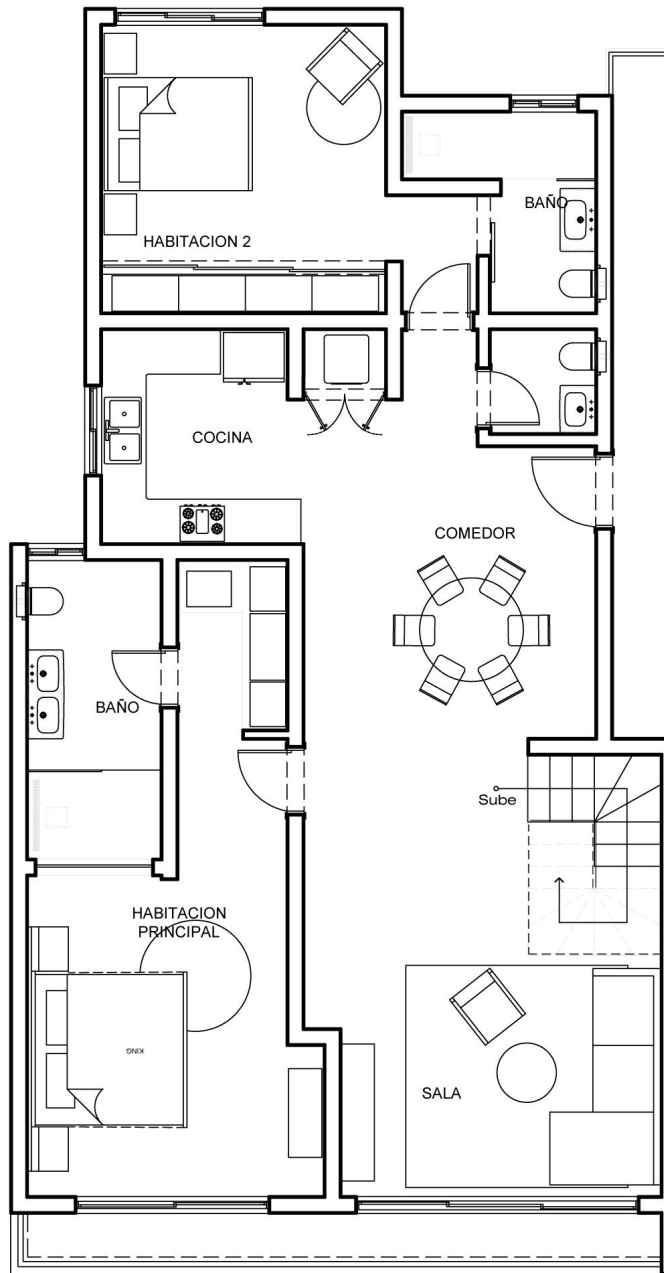
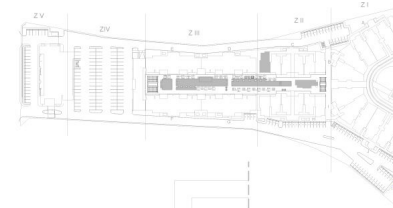

Proyecto:
Apartamento C-401
Nivel: IV - V
Habitaciones: 2
Net M²: 132.90
Terraza en azotea: 133.93
Area comunes: 25.23
Total M²: 292.06

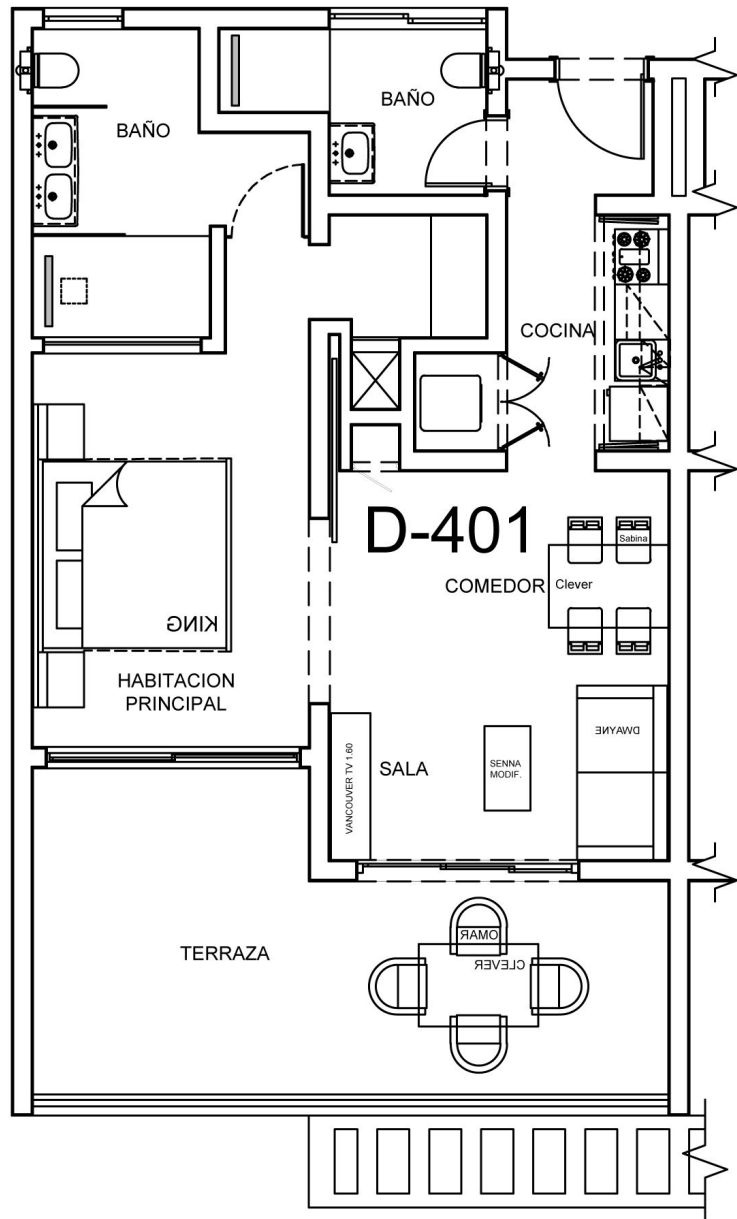
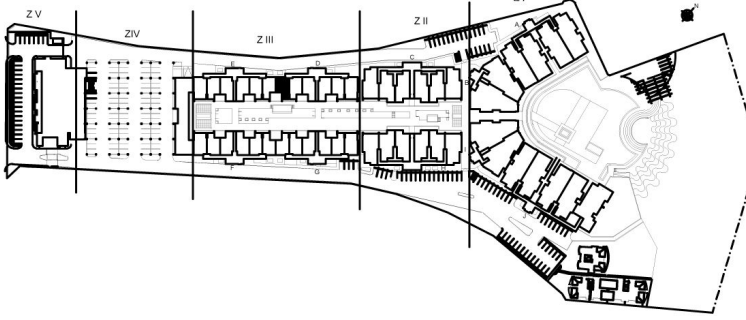

Proyecto: Apartamento D-401

Nivel: IV

Habitaciones: 1

Net M²: 86.10

Area comunes: 17.43

Total M²: 103.53